

56

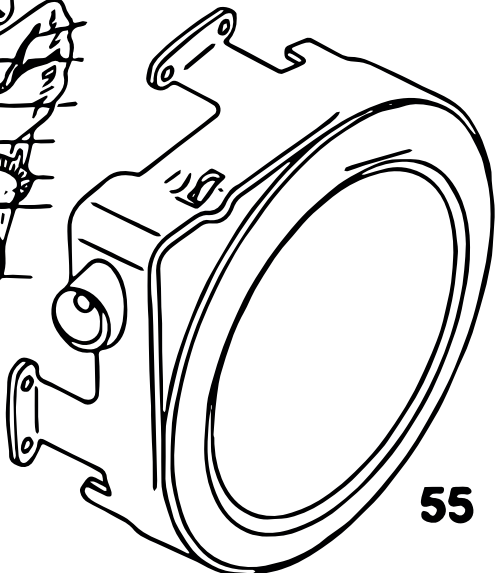
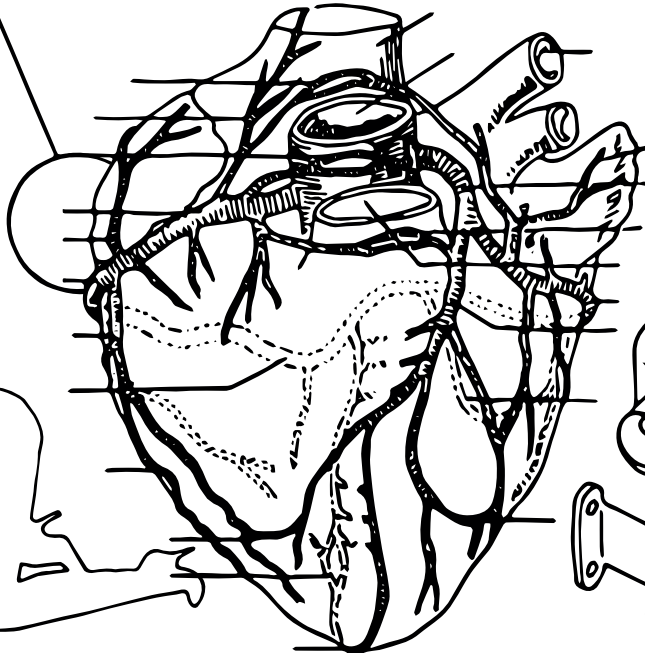
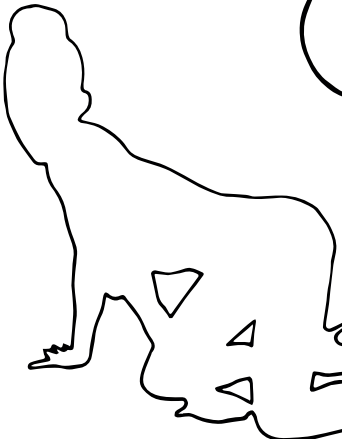
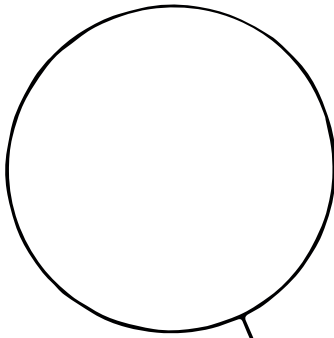
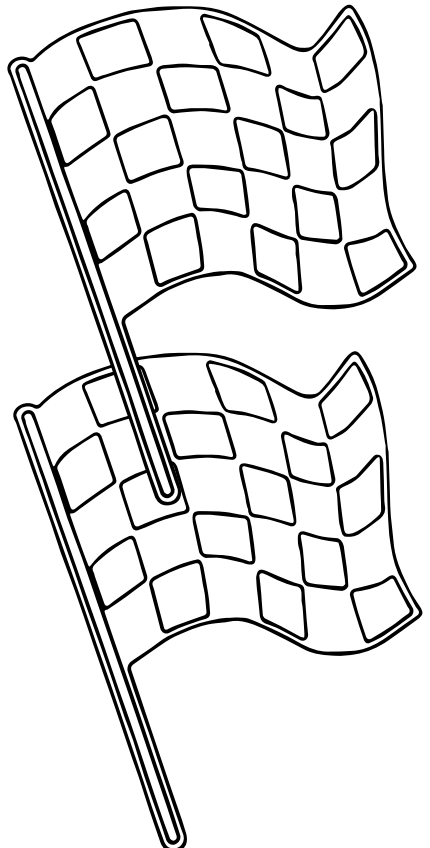
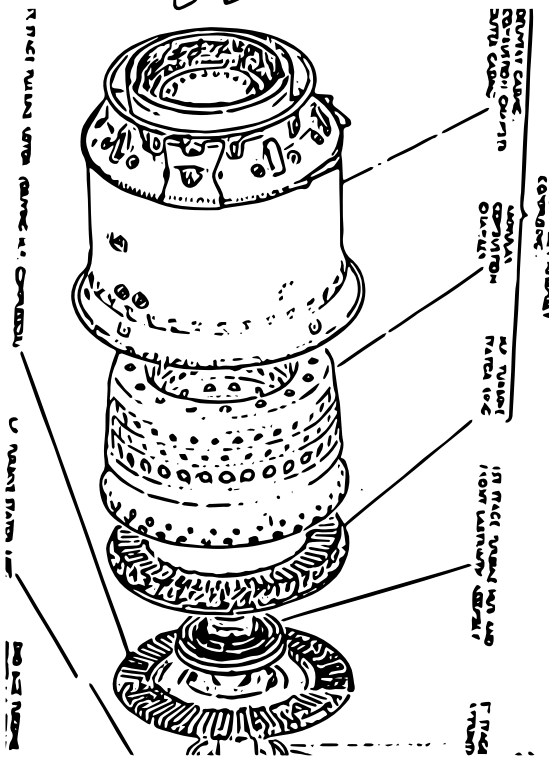
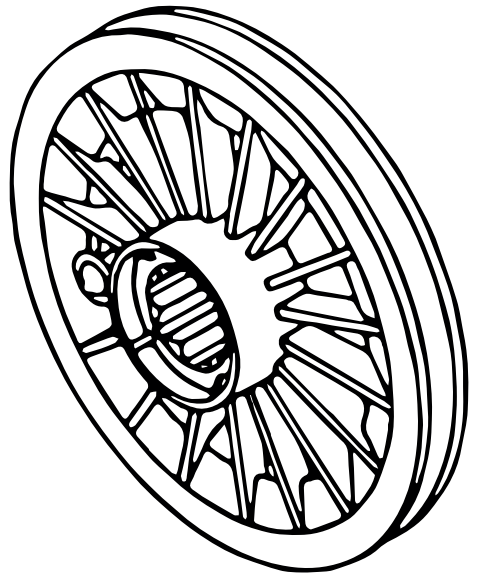

55